

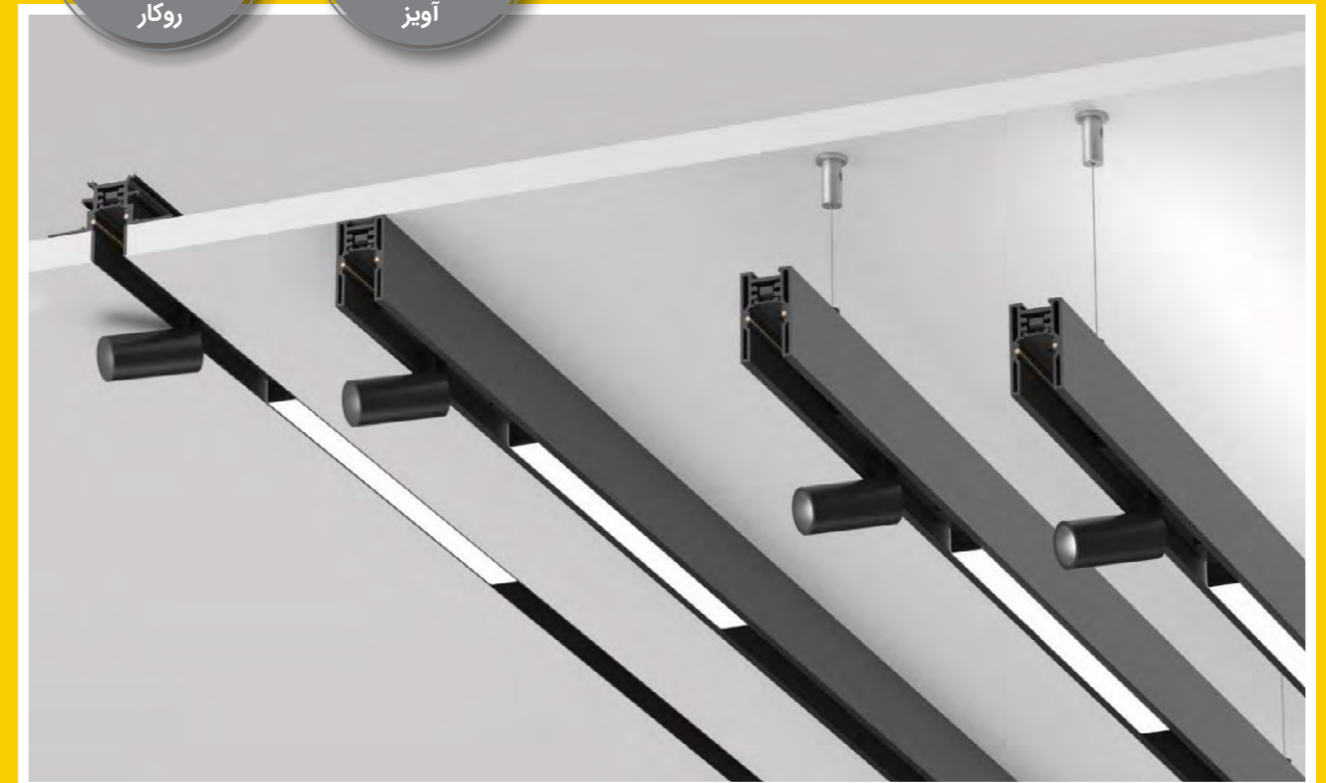

MAGSENSE

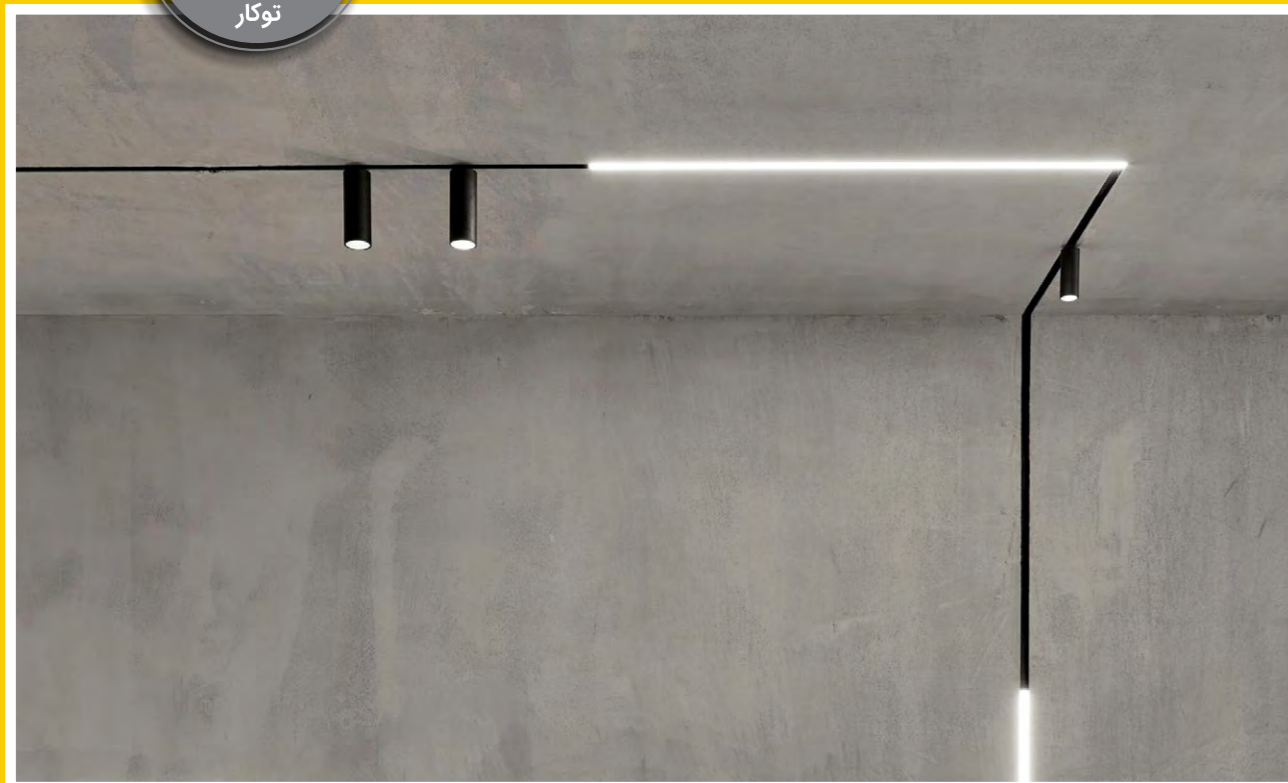

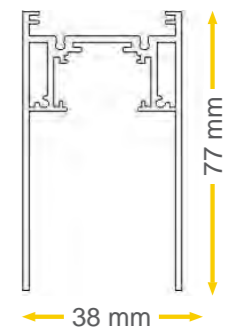
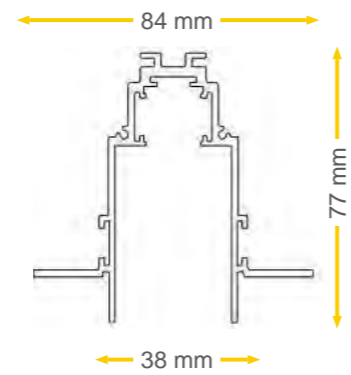
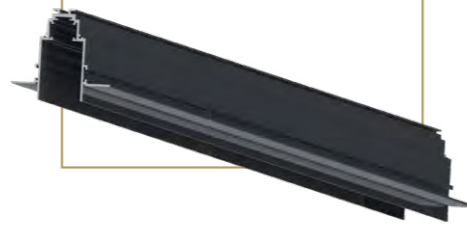

Laser Blade

	Order No.	Power	Lumen	Beam Angle(°)	SIZE(mm)
LASER BLADE	NLMB2712	12	1200	35	270 x 45 x 35
	NLMB5224	24	2400	35	520 x 45 x 35
	NLMB7736	36	3600	35	770 x 45 x 35

Protection Class	Color Temperature(°K)	Body Coating	Body Material
★ Class I	Warm-Cool-Natural	Electrostatic Powder Coating	Die Cast Aluminum



Linear

	Order No.	Power	Lumen	Beam Angle(°)	SIZE(mm)
LINEAR	NLML4016	10	1000	35	400 x 40 x 47
	NLML8020	20	2000	35	800 x 40 x 47
	NLML1024	24	2400	35	1000 x 40 x 47

Protection Class	Color Temperature(°K)	Body Coating	Body Material
★ Class I	Warm-Cool-Natural	Electrostatic Powder Coating	Die Cast Aluminum



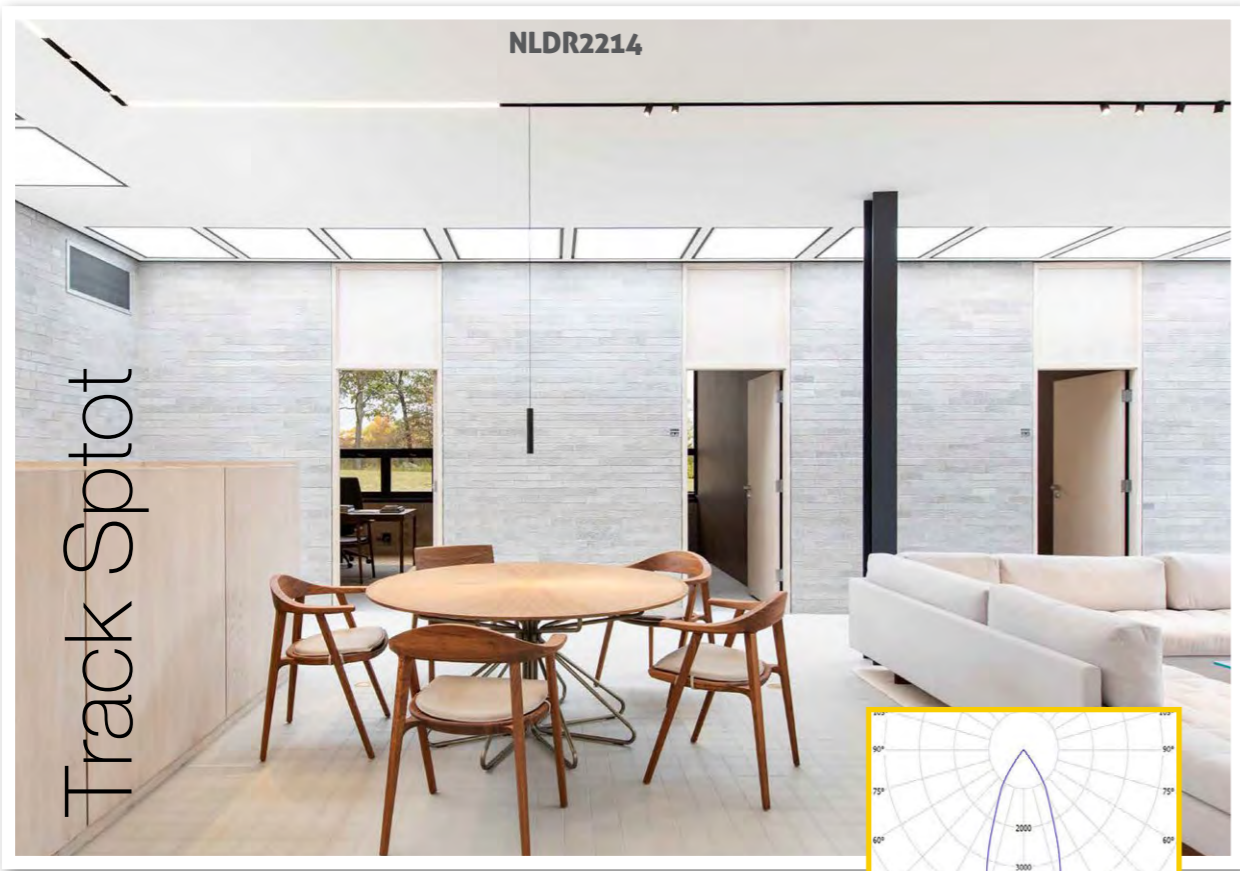

NLDR2214

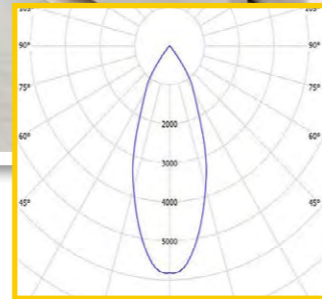

	Order No.	Power (W)	Lumen	Beam Angle(°)	SIZE(mm)
TRACK SPOT	NLMT3506	6	660	36	Ø35 x H130
	NLMT6515	15	1650	36	Ø65 x H105

Protection Class	Color Temperature(°K)	Body Coating	Body Material
★ Class I	Warm-Cool-Natural	Electrostatic Powder Coating	Die Cast Aluminum



Pendant

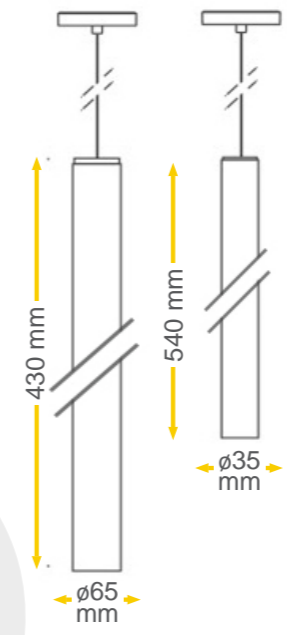

	Order No.	Power (W)	Lumen	Beam Angle(°)	SIZE(mm)
PENDANT	NLMP3506	6	660	36	Ø35 x H540
	NLMP6515	15	1650	36	Ø65 x H430

Protection Class	Color Temperature(°K)	Body Coating	Body Material
★ Class I	Warm-Cool-Natural	Electrostatic Powder Coating	Die Cast Aluminum