



BLADE

OSRAM

| | Order No. | Power | Lumen | Beam Angle(°) | SIZE(mm) |
|-------|-----------|-------|-------|---------------|---------------|
| BLADE | NDLB2412 | 12 | 1200 | 35 | 270 x 45 x 35 |
| | NDLB5424 | 24 | 2400 | 35 | 520 x 45 x 35 |
| | NDLB5436 | 36 | 3600 | 35 | 770 x 45 x 35 |

Protection Class
★ Class I

Color Temperature(°K)
🔥 Warm-Cool-Natural

Body Coating
💧 Electrostatic Powder Coating

Body Material
⚙️ Die Cast Aluminum

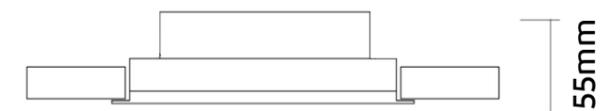
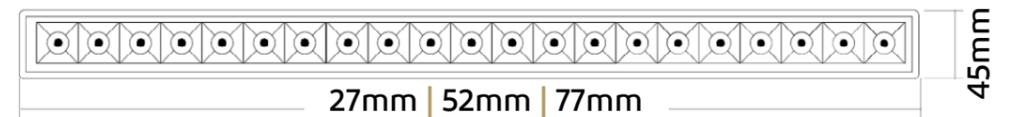

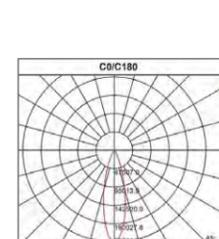
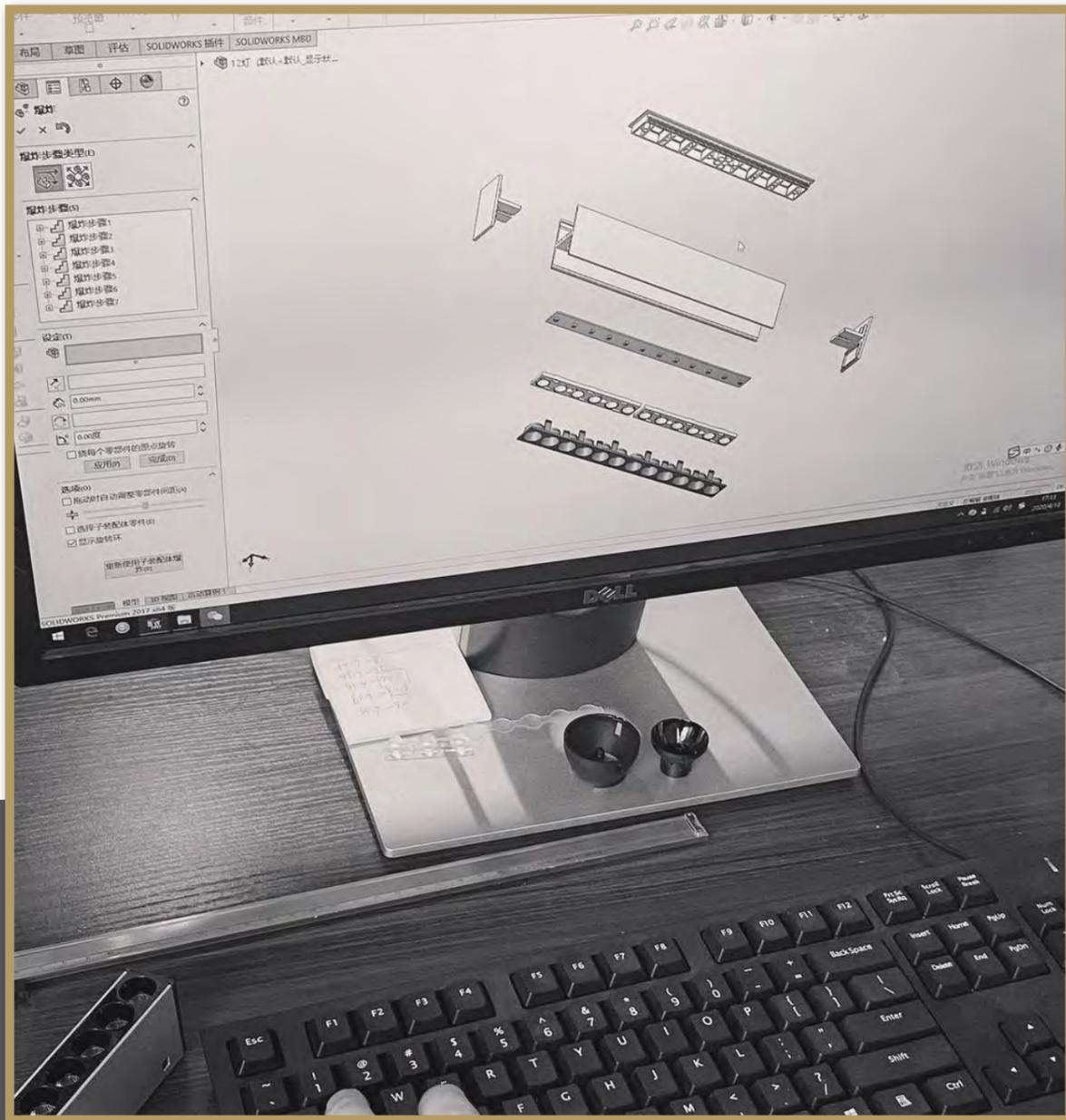







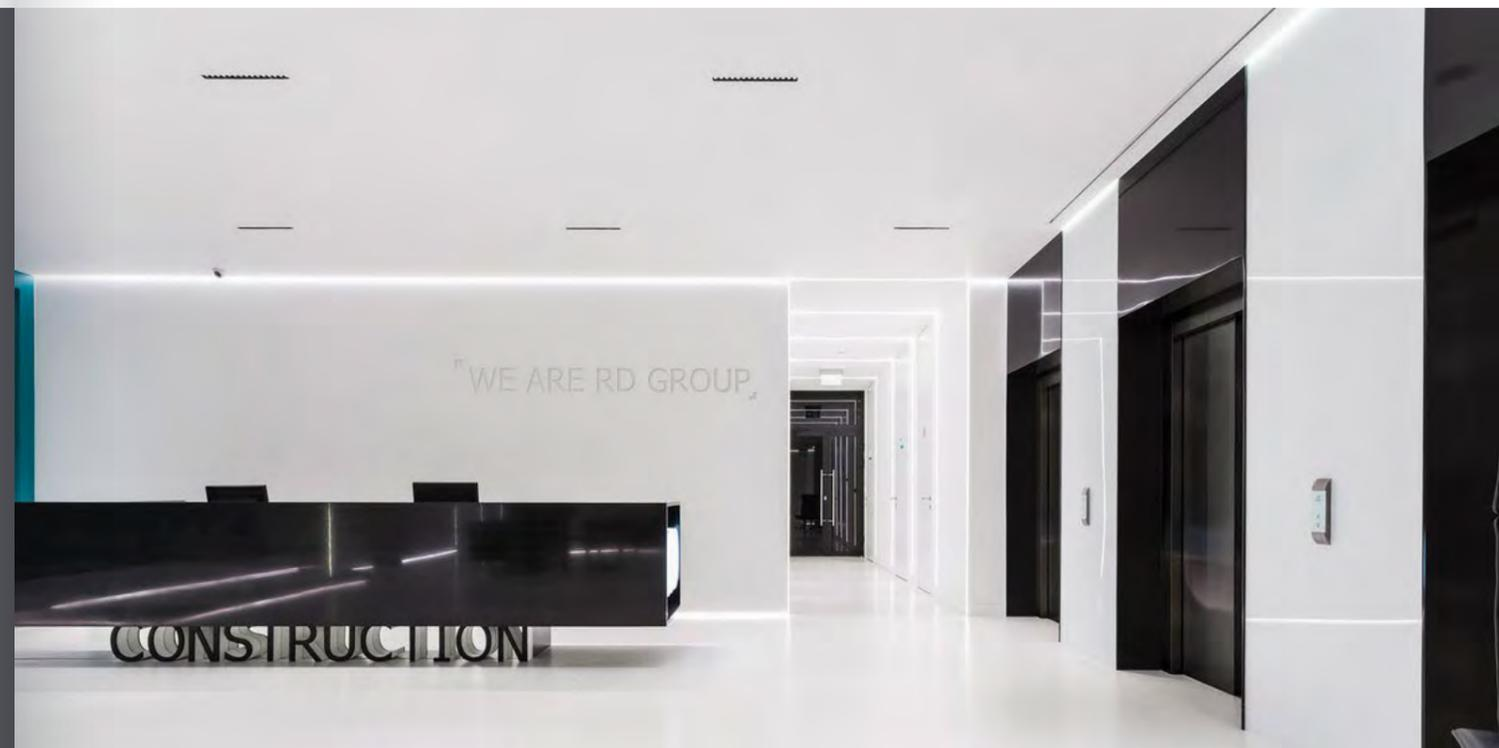

- Ideal for shallow ceiling void
- 2 year warranty
- LED Module Life Time (h) 50000 Hrs
- LED COB light source

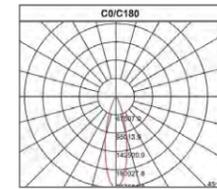
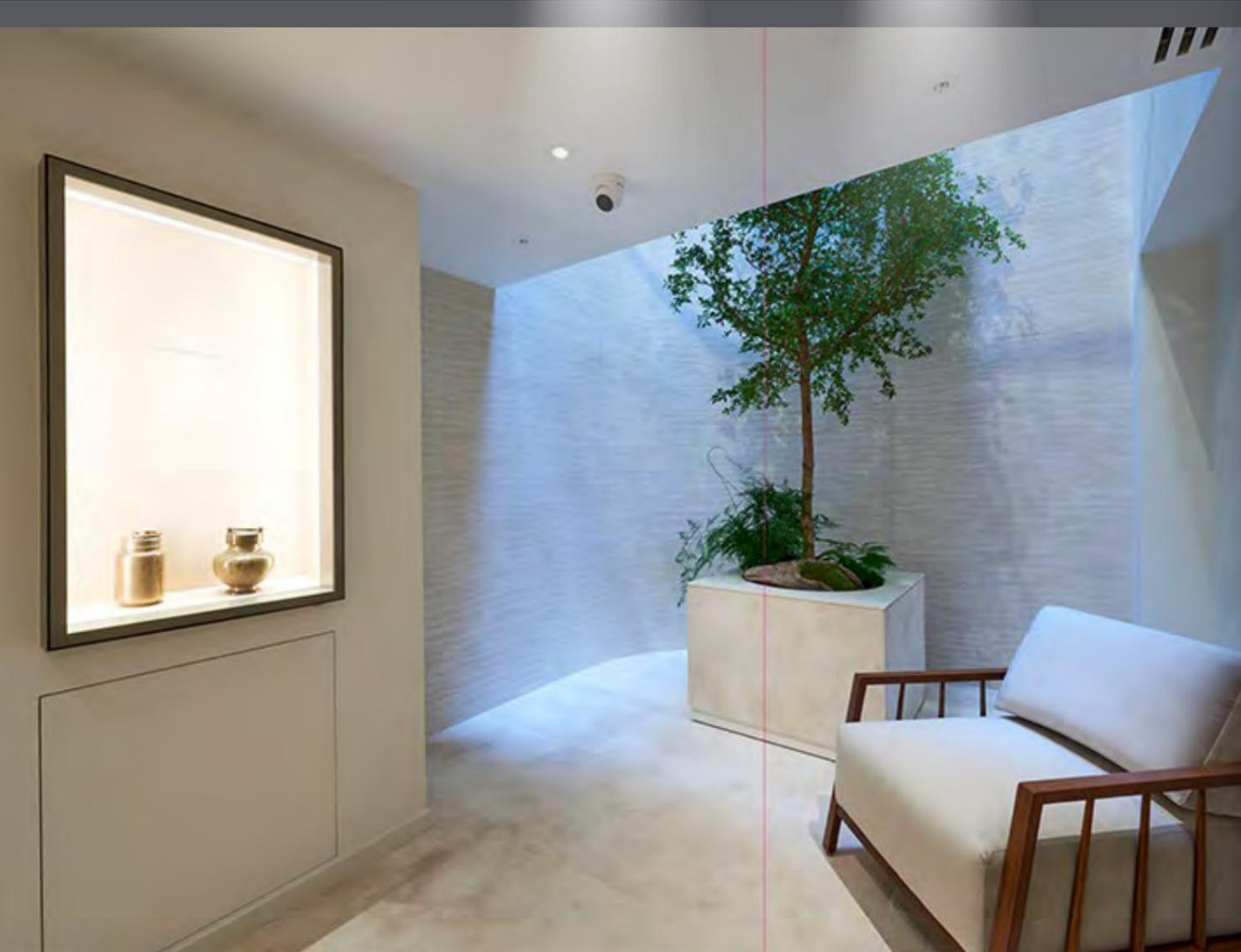
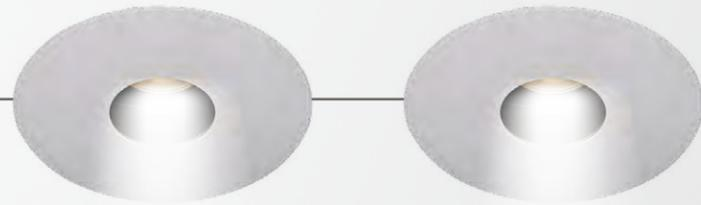

DEEP

PHILIPS



IP22 | 85 CRI | CE

- Ideal for shallow ceiling void
- 2 year warranty
- LED Module Life Time (h) 50000 Hrs
- LED COB light source

★ کاربری:

مناسب برای گالری ها و موزه ها، فروشگاه ها و ساختمان های مسکونی

| | Order No. | Power | Lumen | Beam Angle(°) | SIZE(mm) |
|------------------|-----------------------|------------------------------|-------------------|---------------|------------|
| DEEP | NDLD8112 | 12 Dimmable | 1140 | 24 | Ø87 x H106 |
| Protection Class | Color Temperature(°K) | Body Coating | Body Material | | |
| ★ Class I | Warm | Electrostatic Powder Coating | Die Cast Aluminum | | |



VARIO



PHILIPS

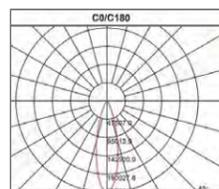

IP22 | 85 CRI | ADJUSTABLE | CE

- Ideal for shallow ceiling void
- 2 year warranty
- LED Module Life Time (h) 50000 Hrs
- LED COB light source

★ کاربری:

مناسب برای گالری‌ها و موزه‌ها، فروشگاه‌ها و ساختمان‌های مسکونی



- 4(W): 70mm
- 12(W): 90mm
- 18(W): 120mm
- 30(W): 140mm

| | Order No. | Power (W) | Lumen | Beam Angle(°) | SIZE(mm) |
|-------|-----------|-----------|-------|---------------|-------------|
| VARIO | NDLV8404 | 4 | 330 | 45 | Ø84 x H40 |
| | NDLV1112 | 12 | 1120 | 45 | Ø110 x H65 |
| | NDLV1418 | 18 | 1650 | 45 | Ø140 x H75 |
| | NDLV11530 | 30 | 1750 | 45 | Ø155 x H105 |

| | | | |
|------------------|-----------------------|------------------------------|-------------------|
| Protection Class | Color Temperature(°K) | Body Coating | Body Material |
| ★ Class I | Warm | Electrostatic Powder Coating | Die Cast Aluminum |

SALIX

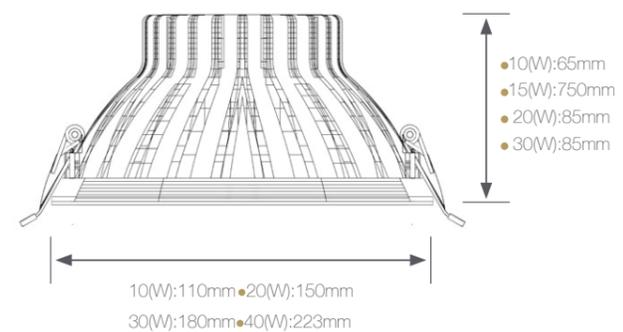
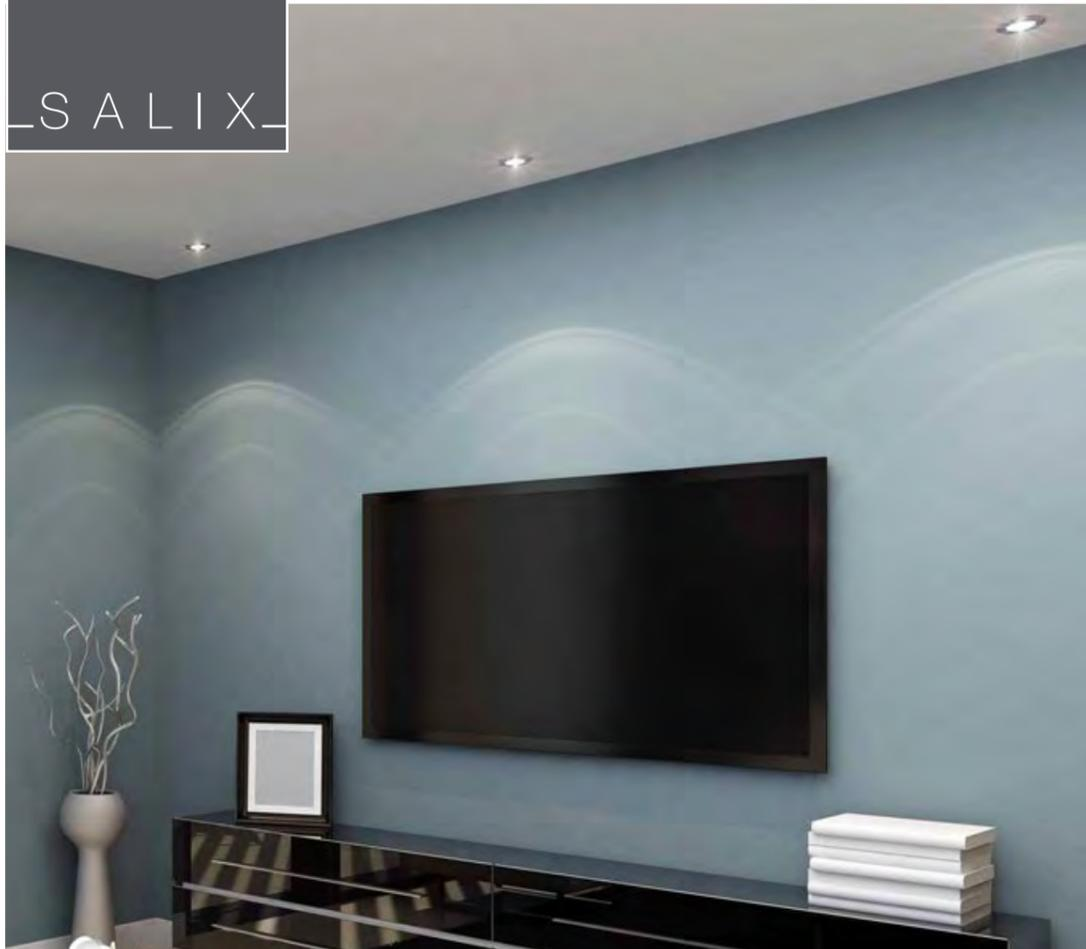

IP22 | 80 CRI | CE

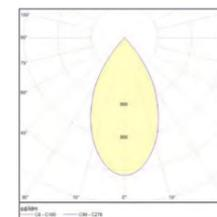

- Ideal for shallow ceiling void
- 2 year warranty
- LED Module Life Time (h) 50000 Hrs
- LED COB light source

★ کاربری:

مناسب برای گالری ها و موزه ها، فروشگاه ها و ساختمان های مسکونی

| | Order No. | Power (W) | Lumen | Beam Angle(°) | SIZE(mm) |
|-----------|-----------|-----------|-------|---------------|------------|
| S A L I X | NDLS1110 | 10 | 700 | 60 | Ø110 x H65 |
| | NDLS1520 | 20 | 1400 | 60 | Ø150 x H75 |
| | NDLS1830 | 30 | 2100 | 60 | Ø180 x H85 |
| | NDLS2240 | 40 | 2800 | 60 | Ø223 x H85 |

Protection Class
★ Class I

Color Temperature(°K)
🔥 Warm-Cool

Body Coating
🔧 Electrostatic Powder Coating

Body Material
⚙️ Die Cast Aluminum

OBLIA

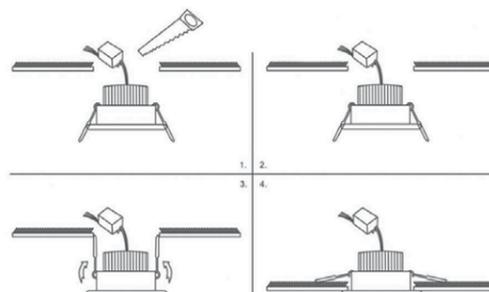

IP22 | 85 CRI | CE

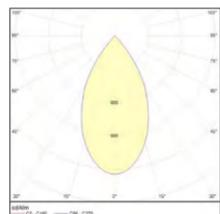

- Ideal for shallow ceiling void
- 2 year warranty
- LED Module Life Time (h) 50000 Hrs
- LED COB light source

★ کاربری:

مناسب برای گالری‌ها و موزه‌ها، فروشگاه‌ها و ساختمان‌های مسکونی

| | Order No. | Power (W) | Lumen | Beam Angle(°) | SIZE(mm) |
|--------------|-----------------|-----------|-------|---------------|-----------|
| OBLIA | NDLO4803 | 3 | 285 | 30 | Ø48 x H40 |

Protection Class
★ Class I

Color Temperature(°K)
Warm-Cool-Natural

Body Coating
Electrostatic Powder Coating

Body Material
Die Cast Aluminum